

PERFORMANCE
MADE
SMARTER

Product manual **4511**

Modbus communication enabler



TEMPERATURE | I.S. INTERFACES | COMMUNICATION INTERFACES | MULTIFUNCTIONAL | ISOLATION | DISPLAY

No. 4511V103-UK
From serial no.: 221207001

PR
electronics

6 Product Pillars

to meet your every need

Individually outstanding, unrivalled in combination

With our innovative, patented technologies, we make signal conditioning smarter and simpler. Our portfolio is composed of six product areas, where we offer a wide range of analog and digital devices covering over a thousand applications in industrial and factory automation. All our products comply with or surpass the highest industry standards, ensuring reliability in even the harshest of environments and have a 5-year warranty for greater peace of mind.

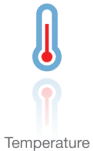

Our range of temperature transmitters and sensors provides the highest level of signal integrity from the measurement point to your control system. You can convert industrial process temperature signals to analog, bus or digital communications using a highly reliable point-to-point solution with a fast response time, automatic self-calibration, sensor error detection, low drift, and top EMC performance in any environment.



We deliver the safest signals by validating our products against the toughest safety standards. Through our commitment to innovation, we have made pioneering achievements in developing I.S. interfaces with SIL 2 Full Assessment that are both efficient and cost-effective. Our comprehensive range of analog and digital intrinsically safe isolation barriers offers multifunctional inputs and outputs, making PR an easy-to-implement site standard. Our backplanes further simplify large installations and provide seamless integration to standard DCS systems.



We provide inexpensive, easy-to-use, future-ready communication interfaces that can access your PR installed base of products. All the interfaces are detachable, have a built-in display for readout of process values and diagnostics, and can be configured via push-buttons. Product specific functionality includes communication via Modbus and Bluetooth and remote access using our PR Process Supervisor (PPS) application, available for iOS and Android.



Our unique range of single devices covering multiple applications is easily deployable as your site standard. Having one variant that applies to a broad range of applications can reduce your installation time and training, and greatly simplify spare parts management at your facilities. Our devices are designed for long-term signal accuracy, low power consumption, immunity to electrical noise and simple programming.



Our compact, fast, high-quality 6 mm isolators are based on microprocessor technology to provide exceptional performance and EMC-immunity for dedicated applications at a very low total cost of ownership. They can be stacked both vertically and horizontally with no air gap separation between units required.



Our display range is characterized by its flexibility and stability. The devices meet nearly every demand for display readout of process signals and have universal input and power supply capabilities. They provide a real-time measurement of your process value no matter the industry and are engineered to provide a user-friendly and reliable relay of information, even in demanding environments.

Modbus communication enabler 4511

Contents

Warning	2
Symbol identification	2
Safety instructions	3
Mounting / demounting of a PR 4500 communication interface	4
Applications	5
Technical characteristics	5
Mounting / installation / programming	5
Order	6
Electrical specifications	6
4511 installation examples	7
Modbus basics	8
4511 Modbus parameter settings	9
Display layout	10
Operating the function keys / display	11
4511 Modbus settings - routing diagram	13
ATEX / UKEX Installation Drawing	15
IECEx Installation Drawing	17
FM Installation Drawing	19
Document history	21

Warning



GENERAL

This device is designed for connection to hazardous electric voltages. Ignoring this warning can result in severe personal injury or mechanical damage.

To avoid the risk of electric shock and fire, the safety instructions of this guide must be observed and the guidelines followed. The specifications must not be exceeded, and the device must only be applied as described in the following.

Prior to the commissioning of the device, this installation guide must be examined carefully.

Only qualified personnel (technicians) should install this device.

If the equipment is used in a manner not specified by the manufacturer, the protection provided by the equipment may be impaired.



**HAZARD-
OUS
VOLTAGE**

Warning

Until the device is fixed, do not connect hazardous voltages to the device. The following operations should only be carried out on a disconnected device and under ESD safe conditions:

General mounting, connection and disconnection of Modbus cable.

Troubleshooting the device.



CAUTION

Warning

Repair of the device must be done by PR electronics A/S only.

Symbol identification



Triangle with an exclamation mark: Read the manual before installation and commissioning of the device in order to avoid incidents that could lead to personal injury or mechanical damage.



The CE mark proves the compliance of the device with the essential requirements of the EU-directives.



The UKCA mark proves the compliance of the device with the essential requirements of the UK regulations.



The double insulation symbol shows that the device is protected by double or reinforced insulation.



Ex devices have been approved according to the ATEX directive / UKEX regulations for use in connection with installations in explosive areas.

Safety instructions

Receipt and unpacking

Unpack the device without damaging it and check whether the device type corresponds to the one ordered. The packing should always follow the device until this has been permanently mounted.

Environment

Avoid direct sunlight, dust, high temperatures, mechanical vibrations and shock, as well as rain and heavy moisture. If necessary, heating in excess of the stated limits for ambient temperatures should be avoided by way of ventilation.

The device must be installed in pollution degree 2 or better. The device is designed to be safe at least under an altitude up to 2 000 m. The device is designed for indoor use.

Mounting

Only qualified technicians who are familiar with the technical terms, warnings, and instructions in this installation guide and who are able to follow these should connect the device. Only devices which are undamaged and free of moist and dust may be installed. The device may be installed and supplied by PR 4590 ConfigMate and PR 4000 / 9000 series devices only.

Should there be any doubt as to the correct handling of the device, please contact your local distributor or, alternatively,

PR electronics A/S
www.prelectronics.com

Cleaning

When disconnected, the device may be cleaned with a cloth moistened with distilled water.

Warranty

PR electronics A/S offers a 5-year warranty on this product.

Liability

To the extent the instructions in this manual are not strictly observed, the customer cannot advance a demand against PR electronics A/S that would otherwise exist according to the concluded sales agreement.

Mounting / demounting of a PR 4500 communication interface

Communication interfaces in the PR 4500 series are detachable displays that can be mounted on a PR 4590 Configmate or all system 4000 / 9000 fronts for programming and signal monitoring.

Mounting

- 1: Insert the tabs of the PR 4500 into the holes at the top of the device.
- 2: Hinge the PR 4500 down until it snaps into place.

Demounting

- 3: Push the release button on the bottom of the PR 4500 and hinge the the PR 4500 out and up.
- 4: With the PR 4500 hinged up, remove from the holes at the top of the device.

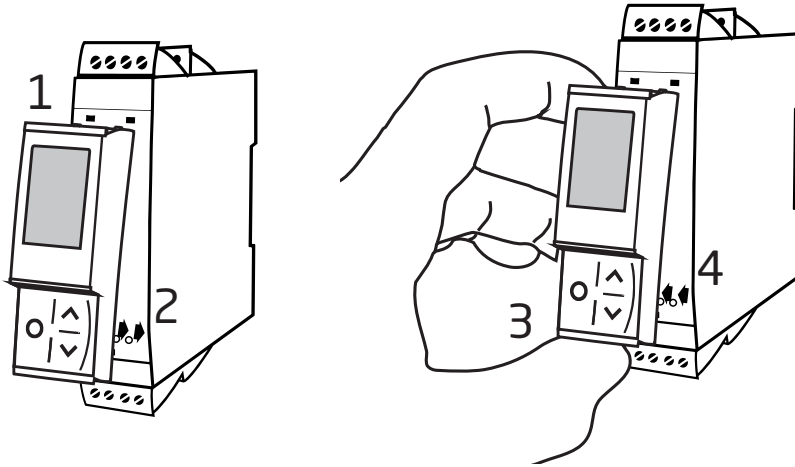

Modbus communication enabler 4511

- Programming display for system 4000 and 9000 devices as well as selected system 3000 devices
- Modbus RTU protocol interface over RS-485
- Monitor process value from the built-in display
- High 2.5 kV isolation to host unit
- Shielded RJ45 Modbus connector on top

Applications

- The 4511 detachable display adds Modbus RTU RS-485 serial communications to all current and future 4000 / 9000 units.
- The unit converts a wide array of sensors and analog device signals measured by the system 4000, like uni- and bipolar mA and voltage signals, potentiometer, lin. R, RTD and TC, to a Modbus communication line signal.
- When mounted on a system 9000 device any signal coming from or going to I.S. classified area, like AI, AO, DI and DO signals, can be converted to a Modbus network.
- All individual unit operating parameters can easily and quickly be configured by using the Modbus communication or by using the front display menu.
- The easily readable 4511 display can be used to read the process signal, simulate the output signal, indicate sensor errors and internal module errors.
- The 4511 can be moved from one device to another. The individual system 3000 / 4000 / 9000 device configuration of a transmitter can be saved and downloaded to subsequent transmitters.

Technical characteristics

- 4511 has full functionality for unit programming, process signal monitoring and diagnostics handling.
- Modbus RTU protocol is supported using a serial RS-485 communication wiring.
- Multidrop half-duplex connection via shielded RJ45 connector.
- High, safe galvanic isolation of 2.5 kVAC between the serial wiring and the connected system 4000 / 9000 units.
- Modbus parameters such as address, baud rate, stop bit(s), and parity bit are configured from the 4511 display, which also stores parameters.

Mounting / installation / programming

- Mounting in Zone 2 / Div 2.
- All configuration data from a PR 3000 / 4000 / 9000 device can be transferred to a PC using the PR 4590.
- Programmed parameters can be protected by a user-defined password.
- When mounted on devices that are installed upside down, a menu item allows the display on the 4511 to be rotated 180° and the up/down buttons to switch function.

Order

Type	Description
4511	Communication enabler
4590	Configmate interface

Electrical specifications

Environmental conditions:

Specifications range	-20°C to +60°C
Storage temperature	-20°C to +85°C
Humidity.	< 95% RH (non-cond.)
Protection degree	IP20
Installation in pollution degree 2 / overvoltage category II.	

Mechanical specifications:

Dimensions (HxWxD)	73.2 x 23.3 x 26.5 mm
Dimensions (HxWxD) w/ 4000/9000 unit	109 x 23.5 x 131 mm
Weight approx.	30 g
Connection	RJ45 - shielded

Common specifications:

Power consumption	≤ 0.15 W
Isolation voltage - test / working	2.5 kVAC / 250 VAC reinforced isolation

Extended EMC immunity:

NAMUR NE 21, A criterion, burst	No loss of communication
---	--------------------------

Signal / noise ratio	> 60 dB
Update rate / response time	> 50 Hz / < 20 ms
Signal type	RS-485 half duplex
Serial protocol	Modbus RTU
Modbus mode.	RTU - slave
Devices on an RS485 line	Up to 32 (without a repeater)
Data rates, baud	2400, 4800, 9600, 19200, 38400, 57600, 115200
Automatic baudrate detection	Yes - can be configured ON or OFF
Parity.	Even, Odd, None
Stop bit(s)	1 or 2
Digital addressing	1...247
Response delay.	0...1000 ms

Observed authority requirements:

EMC.	2014/30/EU & UK SI 2016/1091
ATEX	2014/34/EU & UK SI 2016/1107
LVD	2014/34/EU & UK SI 2010/1101
RoHS	2011/65/EU & UK SI 2012/3032

Approvals:

DNV, Ships & Offshore.	TAA00000JD
c UL us, UL 61010-1.	E314307
EAC	TR-CU 020/2011

Ex:

ATEX	DEKRA 13ATEX0098 X
IECEx	DEK 13.0026 X
FM, US	FM22US0014X
FM, CA	FM22CA0009X
UKCA	DEKRA 21UKEX0167X

4511 installation examples

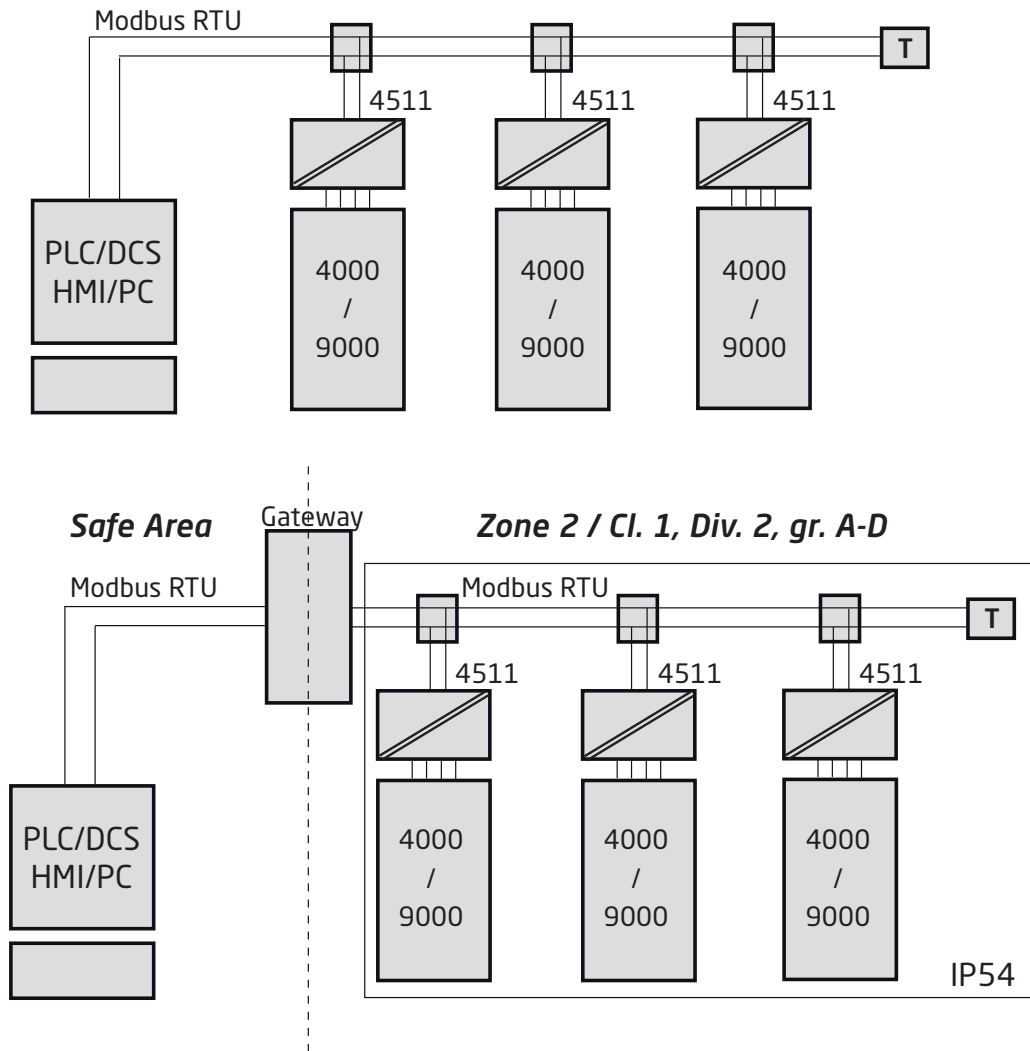

Modbus basics

Modbus is a “master-slave” system..., where the “master” communicates with one or multiple “slaves”.

The master typically is a PLC (Programmable Logic Controller), DCS (Distributed Control System), HMI (Human Machine Interface), RTU (Remote Terminal Unit) or PC.

The three most common Modbus versions used are: MODBUS ASCII, MODBUS RTU and MODBUS/TCP.

In Modbus RTU, data is coded in binary, and requires only one communication byte per data byte. This is ideal for use over multi-drop RS485 networks, at speeds up to 115,200 bps.

The most common speeds are 9,600 bps and 19,200 bps.

Modbus RTU is the most widely used industrial protocol and is supported by the 4511.

Modbus RTU:

To communicate with a slave device, the master sends a message containing:

Device Address - Function Code - Data - Error Check

The Device Address is a number from 0 to 247.

Messages sent to address 0 (broadcast messages) will be accepted by all slaves, but numbers 1-247 are addresses of specific devices.

With the exception of broadcast messages, a slave device always responds to a Modbus message so the master knows the message was received.

4511 Supported Modbus Function Codes:

Command	Function code
Read Holding Registers*	03
Read Input Registers*	04
Write Single Register	06
Diagnostics	08
Write Multiple Registers	16

*Holding Registers and Input Registers contain identical data in PR 4511.

The Function Code defines the command that the slave device is to execute, such as read data, accept data, report status. Some function codes have subfunction codes.

The Data defines addresses in the device’s memory map for read functions, contains data values to be written into the device’s memory, or contains other information needed to carry out the function requested.

The Error Check is a 16-bit numeric value representing the Cyclic Redundancy Check (CRC).

Maximum number of registers which can be read or written at once:

For a read command, the limit is 8 registers at a baud rate up to 38,400 bps, 16 registers @ 57,800 bps and 32 registers @ 115,200 bps.

For a write command, the limit is 123 registers at baud rates up to 115,200 bps.

RJ45 Modbus Connector

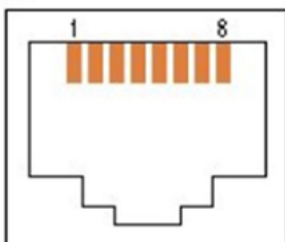

Pin 5: RS485 A line

Pin 4: RS485 B line

Pin 8: RS485 GND and shield

4511 Modbus parameter settings

Automatic Baudrate Detection:

Can be configured YES or **NO**

Supported baudrates:

2400, 4800, 9600, **19.2k**, 38.4k, 57.6k, 115.2k bps

Parity Mode:

Even, Odd or None parity

Stop Bits:

1 or 2 stop bits

Response delay:

0...1000 ms (**0 ms = default**)

Modbus slave addressing range:

1 - 247 (**247 = default address**)

Modbus Parameter Storage:

Saved in non-volatile memory in the 4511 device

(Factory Default Values are marked in **bold**)

Modbus RTU segment line termination:

A 120 Ohm resistor should be installed on both ends of a RS485 Modbus RTU segment loop to prevent signal echoes from corrupting data on the line.

Display layout

By default, the PR 4511 enters monitor mode for process surveillance. With the front keys, the 4511 can enter programming or simulation mode.

Layout for 3000/4000 and 9000 series products (in monitor mode)

PR 3000 / 4000	Line 1 shows the scaled process value.	<p>6.746 l/min TAG788 ⊕ ⊕ ↓ ⊕ 1 2</p>
	Line 2 shows the selected engineering unit.	
	Line 3 shows analog output value or TAG no.	
	Line 4 shows status for relay, communication and e.g. signal trending.	
PR 9000	Line 1 shows status for input channel/-s.	<p>I ✓ II! I ON II CABR ⊕ 1 ⊕</p>
	Line 2 and 3 show analog output value / digital output status / analog input value / TAG no. where applicable or alternating values.	
	Line 4 shows status for relay, communication and e.g. signal trending.	

Operating the function keys / display

In general

When using the PR 4511 for configuration of a PR 4000 or PR 9000 device, you will be guided through all parameters and can choose the settings which fit the application. For each menu there is a scrolling help text which is automatically shown in line 3 on the display.

Configuration is carried out by use of the 3 function keys:







- ⏪ will increase the numerical value or choose the next parameter
- ⏩ will decrease the numerical value or choose the previous parameter
- ⊗ will save the chosen value and proceed to the next menu

When configuration is completed, the display will return to the default state (monitor). Pressing and holding ⊗ will return to the previous menu or return to the default state without saving the changed values or parameters.

If no key is activated for 1 minute, the display will return to the default state without saving the changed values or parameters.

For device-specific programming menus, please refer to the user manual for each device, e.g. PR 4116.

4511 display icons explained

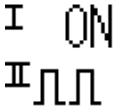
PR 3000 / 4000		Relay status (relay energized). Icon with 1 or 2 blinking indicates delayed relay action (programmable on/off delay).
		Arrow up/down indicates process value is trending higher/lower.
		Circular indicator confirms display-to-host communication.
PR 9000		Relay status (Relay energized). Icon with 1 or 2 blinking indicates delayed relay action (programmable on/off delay).
		Arrow up/down indicates process value is trending higher/lower.
		Circular indicator confirms display-to-host communication. Steady dot indicates device is SIL-locked; blinking dot indicates non SIL-locked device.
		Checkmark indicates input OK or '!' for error condition / device error on channel input.
		One or two channels: ON indicates that the relay / digital output is energized. OFF = not energized. The pulse icon indicates input frequency above 1 Hz. Device faults are displayed in channel 1 status. Device or sensors fault messages e.g. CA.BR (cable break) are device-dependent; please consult device manual for a complete list of applicable error codes.

4511 functions

The PR 4511 gives access to a number of functions which can be reached by answering "Yes" to the menu point "ADV.SET" (see "4511 Modbus settings - routing diagram" on page 13).

Modbus setup (MODB): With the Modbus RTU interface you can set Modbus address, parity, stop bit, response delay and baud rate.

Display orientation (ORIEN): The menu item "ORIEN" allows the user to rotate the display 180 degrees for correct operation with upside down mounting of the device.

4511 Modbus settings - routing diagram

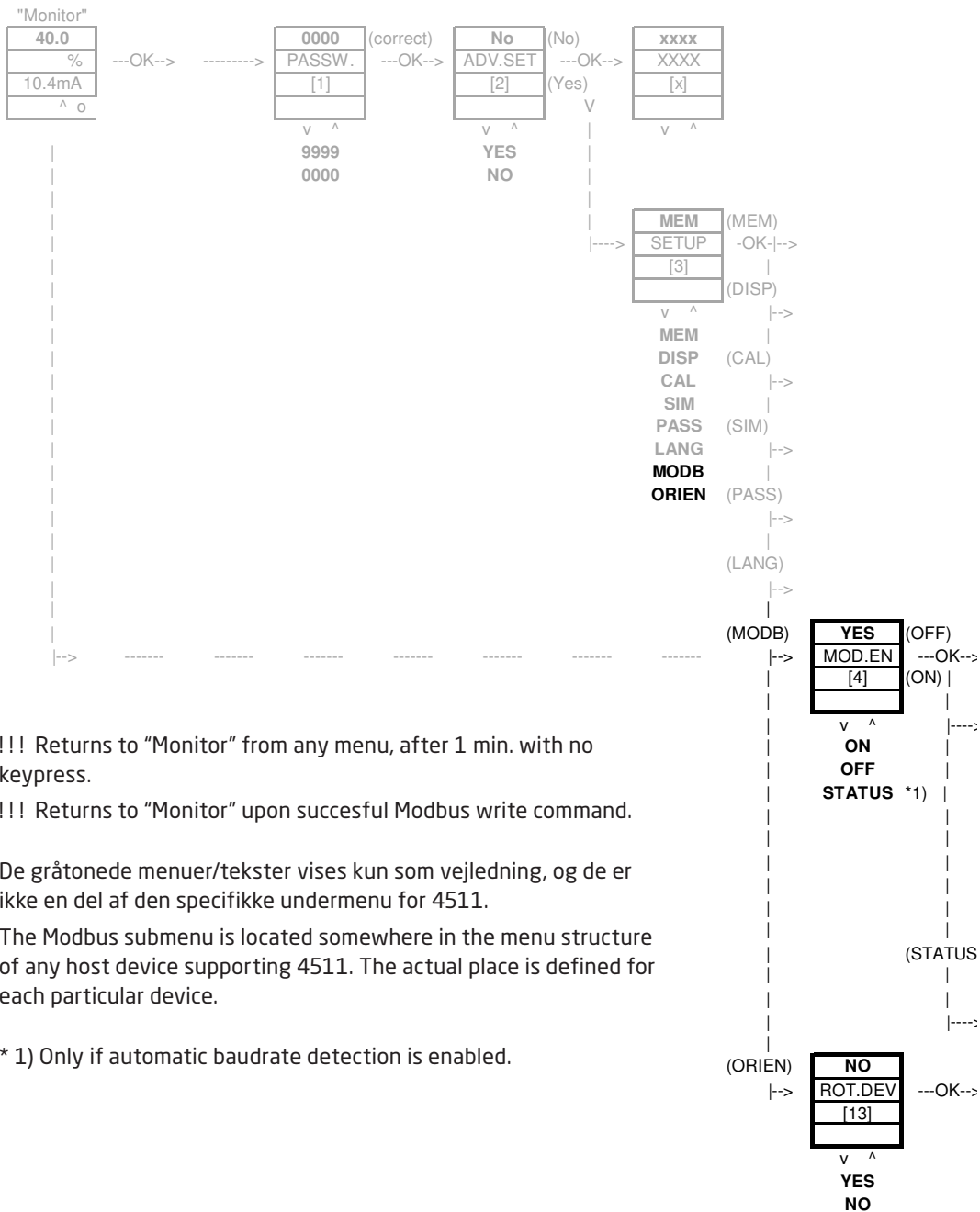

!!! Returns to "Monitor" from any menu, after 1 min. with no keypress.

!!! Returns to "Monitor" upon succesful Modbus write command.

De gråtonede menuer/tekster vises kun som vejledning, og de er ikke en del af den specifikke undermenu for 4511.

The Modbus submenu is located somewhere in the menu structure of any host device supporting 4511. The actual place is defined for each particular device.

* 1) Only if automatic baudrate detection is enabled.

SCROLLING HELPTEXTS:

- [1] Set correct password
- [2] Enter advanced setup menu?
- [3] Enter Language setup
Enter Password setup
Enter Simulation mode
Perform Process calibration
Enter Display setup
Perform Memory operations
Enter Modbus setup
Enter Rotation setup
- [4] Enable modbus communication
Disable Modbus communication
See automatic baudrate detection status
- [5] Reset Modbus to default?
- [6] Select Modbus slave address
- [7] Select parity for Modbus
- [8] Select number of stop bits
- [9] Select response delay in ms
- [10] Enable automatic baudrate detection
- [11] Modbus baudrate not detected
Searching for Modbus baudrate
Modbus baudrate detected
- [12] Select baudrate in bps
- [13] Rotate device upside down?

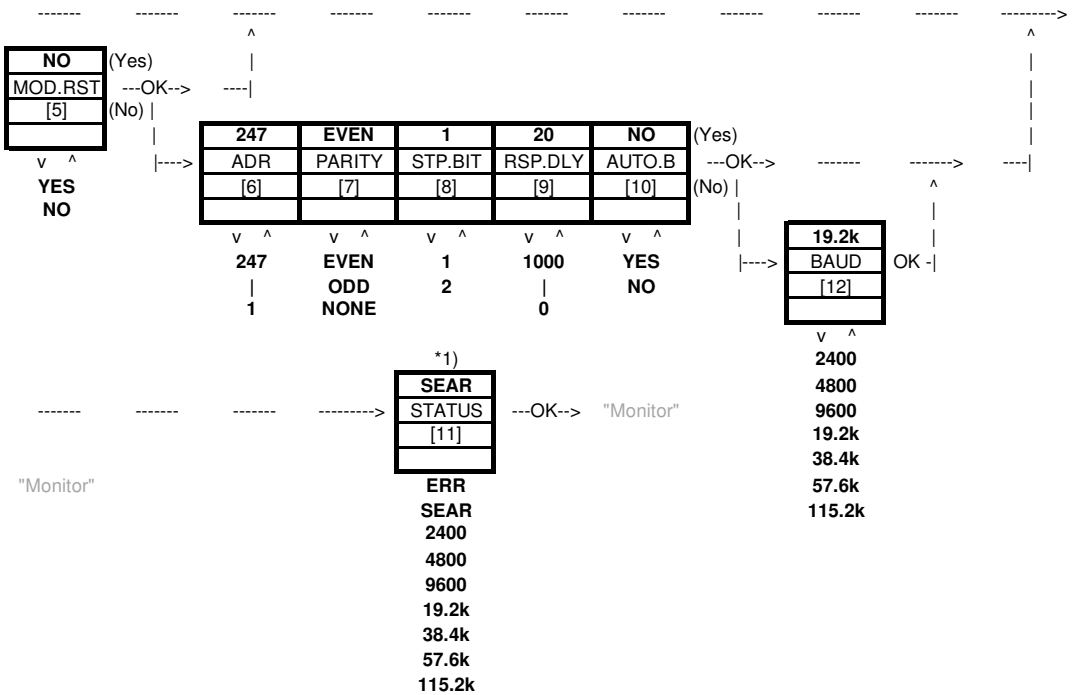

Default settings:

- Baud rate: 19.2 kbps
- Parity mode: Even
- Stop bit: 1
- Address: 247
- Reponse delay: 0 ms

ATEX/UKEX Installation drawing 4500QA01-V1R0

Ex Certificates DEKRA 13ATEX0098 X
DEKRA 21UKEX0167X
Standards: EN IEC 60079-0
EN 60079-7

Marking:  II 3G Ex ec IIC T5

Temperature range $-20^{\circ}\text{C} \leq T_a \leq +60^{\circ}\text{C}$

ATEX/UKEX Installation Instructions

For safe installation of the 4500 series of products the following must be observed.

Hazardous Area
II 3G Ex IIC

Unclassified Area

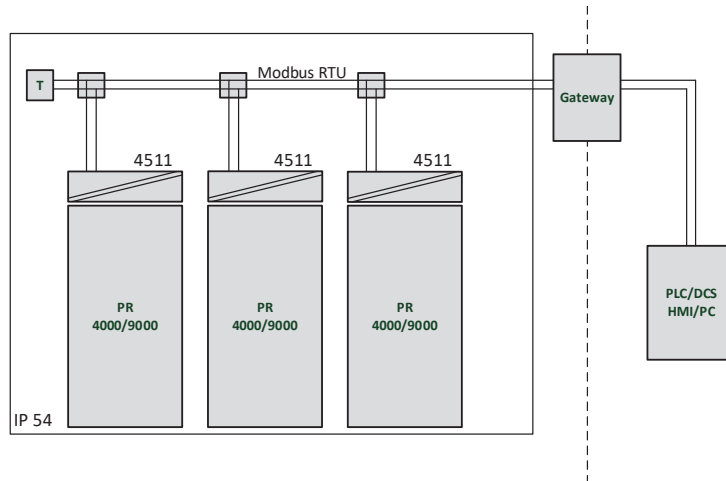

Hazardous Area
II 3G Ex IIC

Unclassified Area

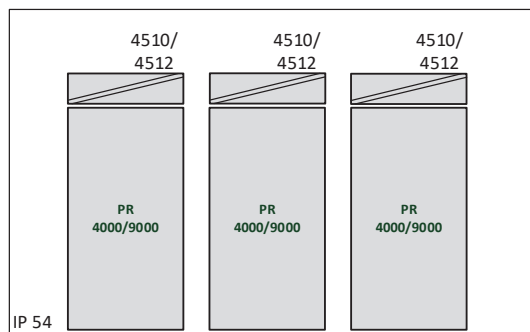

General installation instructions

Year of manufacture can be taken from the first two digits in the serial number.

For safe Ex installation the following must be observed: The device must be installed by qualified personnel who are familiar with the national and international laws, directives and standards that apply to this area.

To prevent ignition of the explosive atmospheres do not separate connectors when energized and an explosive gas mixture is present.

To avoid the risk of explosion due to electrostatic charging of the enclosure, do not handle the units unless the area is known to be safe, or appropriate safety measures are taken to avoid electrostatic discharge.

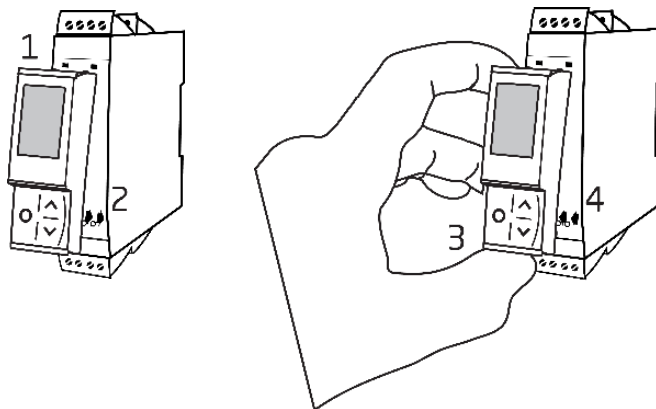

Mounting of PR 4500 communications interface:

1. Insert the tabs of the PR 4500 into the slots at the top of the device.
2. Hinge the PR 4500 down until it snaps into place.

Demounting of the PR 4500 communication interfaces:

3. Push the release button on the bottom of the PR 4500 and hinge the PR 4500 out and up.
4. With the PR 4500 hinged up, remove from the slots at the top of the device.

Specific Conditions of Use

- The equipment shall only be used in an area of not more than pollution degree 2, as defined in EN IEC 60664-1.
- The devices must be installed in a suitable enclosure providing a degree of protection of at least IP54 according to EN IEC 60079-0, taking into account the environmental conditions under which the equipment will be used.
- Transient protection shall be provided that is set at a level not exceeding 140% of the peak rated voltage value at the supply terminals to the equipment.

IECEX Installation drawing 4500QI01-V1R0

Ex Certificates IECEX DEK 13.0026X

Standards: IEC 60079-0
IEC 60079-7

Marking: Ex ec IIC T5 Gc

Temperature range $-20^{\circ}\text{C} \leq T_a \leq +60^{\circ}\text{C}$

IECEX Installation Instructions

For safe installation of the 4500 series of products the following must be observed.

Hazardous Area

Unclassified Area

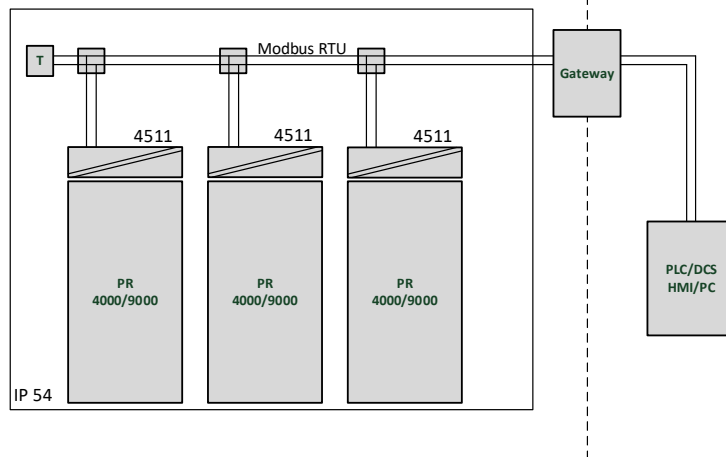

Hazardous Area

Unclassified Area

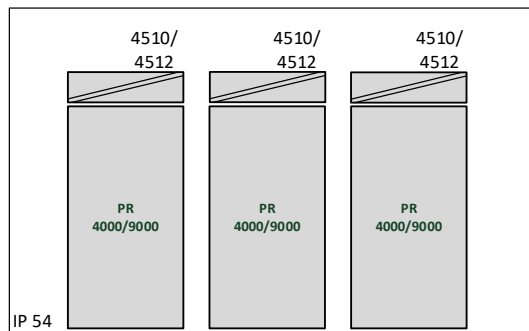

General installation instructions

Year of manufacture can be taken from the first two digits in the serial number.

For safe Ex installation the following must be observed: The device must be installed by qualified personnel who are familiar with the national and international laws, directives and standards that apply to this area.

To prevent ignition of the explosive atmospheres do not separate connectors when energized and an explosive gas mixture is present.

To avoid the risk of explosion due to electrostatic charging of the enclosure, do not handle the units unless the area is known to be safe, or appropriate safety measures are taken to avoid electrostatic discharge.

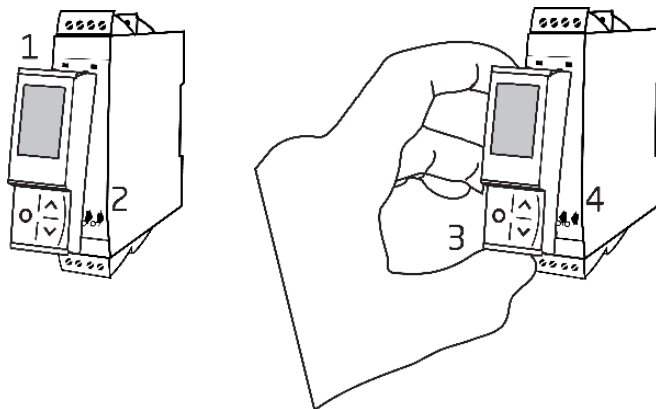

Mounting of PR 4500 communications interface:

1. Insert the tabs of the PR 4500 into the slots at the top of the device.
2. Hinge the PR 4500 down until it snaps into place.

Demounting of the PR 4500 communication interfaces:

3. Push the release button on the bottom of the PR 4500 and hinge the PR 4500 out and up.
4. With the PR 4500 hinged up, remove from the slots at the top of the device.

Specific Conditions of Use

- The equipment shall only be used in an area of not more than pollution degree 2, as defined in EN IEC 60664-1.
- The devices must be installed in a suitable enclosure providing a degree of protection of at least IP54 according to EN IEC 60079-0, taking into account the environmental conditions under which the equipment will be used.
- Transient protection shall be provided that is set at a level not exceeding 140% of the peak rated voltage value at the supply terminals to the equipment.

FM Installation drawing 4500QF01-V1R0

FM Certificates

FM22US0014X

FM22CA0009X

Standards:

See Certificate

Marking:



CL I Div 2 GP A,B,C,D T5

CL I Zone 2 AEx/Ex ec IIC T5 Gc

Temperature range $-20^{\circ}\text{C} \leq T_a \leq +60^{\circ}\text{C}$

AEx/Ex ec Installation Instructions

For safe installation of the 4500 series of products the following must be observed.

Hazardous Area

CL I Div2 GP A,B,C,D

CL I Zone 2 AEx/Ex ec IIC T5 Gc

Unclassified Area

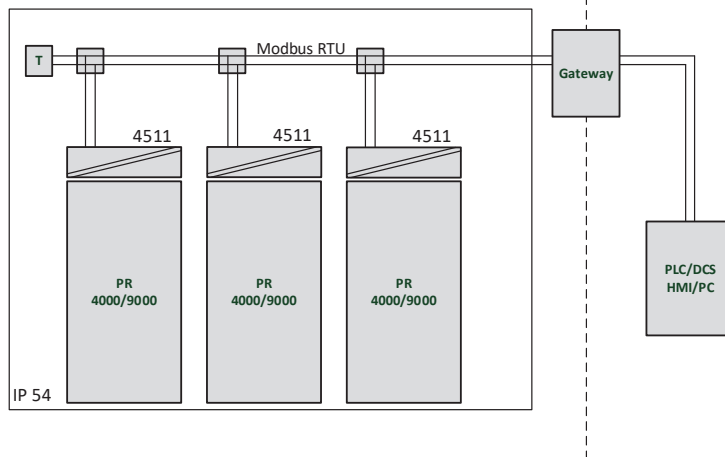

Hazardous Area

CL I Div2 GP A,B,C,D

CL I Zone 2 AEx/Ex ec IIC T5 Gc

Unclassified Area

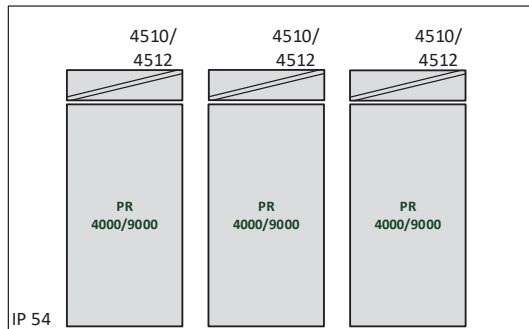

General installation instructions

Year of manufacture can be taken from the first two digits in the serial number.

For safe Ex installation the following must be observed: The device must be installed by qualified personnel who are familiar with the national and international laws, directives and standards that apply to this area.

To prevent ignition of the explosive atmospheres do not separate connectors when energized and an explosive gas mixture is present.

To avoid the risk of explosion due to electrostatic charging of the enclosure, do not handle the units unless the area is known to be safe, or appropriate safety measures are taken to avoid electrostatic discharge.

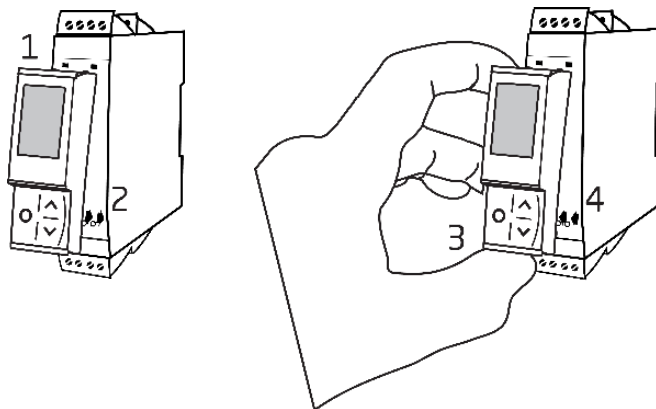

Mounting of PR 4500 communications interface:

1. Insert the tabs of the PR 4500 into the slots at the top of the device.
2. Hinge the PR 4500 down until it snaps into place.

Demounting of the PR 4500 communication interfaces:

3. Push the release button on the bottom of the PR 4500 and hinge the PR 4500 out and up.
4. With the PR 4500 hinged up, remove from the slots at the top of the device.

Specific Conditions of Use

Class 1, Division 2

In Class I, Division 2 installations, the subject equipment shall be mounted within a tool-secured enclosure which is capable of accepting one or more of the Class I, Division 2 wiring methods specified in the National NEC or CEC.

Class 1, Zone 2

- The equipment shall be installed within an enclosure that provides a minimum ingress protection of IP54 in accordance with ANSI/UL 60079-0 or CSA C22.2 No. 60079-0.
- The equipment shall only be used in an area of at least pollution degree 2, as defined in IEC 60664-1.
- Transient protection shall be provided that is set at a level not exceeding 140% of the peak rated voltage value at the supply terminals to the equipment.

Document history

The following list provides notes concerning revisions of this document.

Rev. ID	Date	Notes
102	2124	4801 discontinued - references deleted.
103	2220	ATEX and IECEx approvals updated - Ex na changed to Ex ec. UKEX approval added.

We are near you, *all over the world*

Our trusted red boxes are supported wherever you are

All our devices are backed by expert service and a 5-year warranty. With each product you purchase, you receive personal technical support and guidance, day-to-day delivery, repair without charge within the warranty period and easily accessible documentation.

We are headquartered in Denmark, and have offices and authorized partners the world over. We are a local business

with a global reach. This means that we are always nearby and know your local markets well.

We are committed to your satisfaction and provide PERFORMANCE MADE SMARTER all around the world.

For more information on our warranty program, or to meet with a sales representative in your region, visit prelectronics.com.

Benefit today from *PERFORMANCE MADE SMARTER*

PR electronics is the leading technology company specialized in making industrial process control safer, more reliable and more efficient. Since 1974, we have been dedicated to perfecting our core competence of innovating high precision technology with low power consumption. This dedication continues to set new standards for products communicating, monitoring and connecting our customers' process measurement points to their process control systems.

Our innovative, patented technologies are derived from our extensive R&D facilities and from having a great understanding of our customers' needs and processes. We are guided by principles of simplicity, focus, courage and excellence, enabling some of the world's greatest companies to achieve PERFORMANCE MADE SMARTER.